

ATTACHING THE BASSINET

Before setting up bassinet, make sure all rails have become rigid.
The bassinet must be fully assembled and installed before using

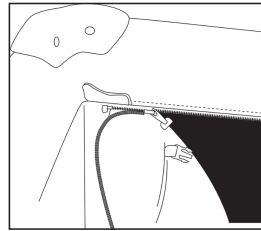

1. Zip up the bassinet and secure the zipper head with buckle, then cover it with flap.

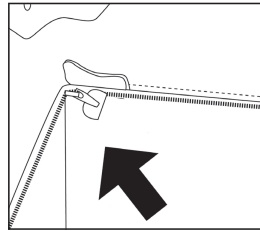

2. Must zip up the bassinet completely without crevice before using.

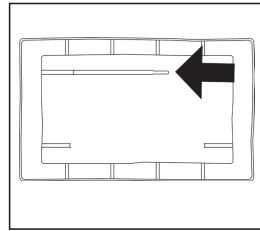

3. Slide two tubes in the pocket as picture shown.

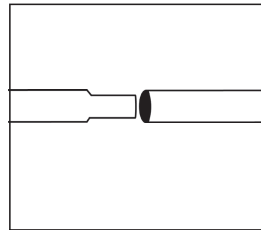

4. Assemble the connecting tubes as picture shown.

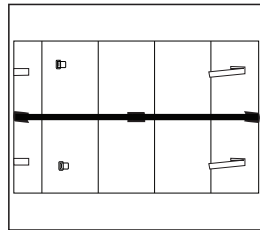

5. Slide the remaining tubes in the pocket behind the mattress and assemble it.

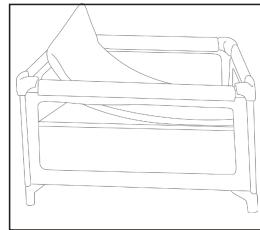

6. Place the mattress into the bassinet. Place mattress, soft side up

ADJUSTING TO CO-SLEEPING MODE

The travel cot can be fixed to the parent's bed (co-sleeping mode).

1. Slide the adjustor inwards as photo shown
2. Adjust the slide door down
3. Position the travel cot next to the bed
4. Lift up the slide door when parents is not around.

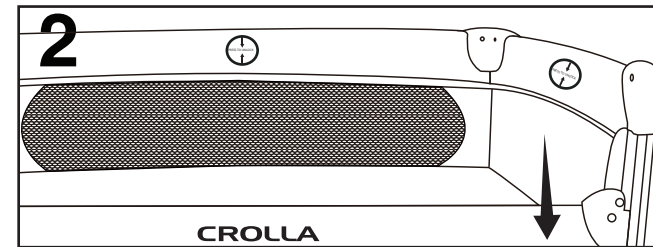
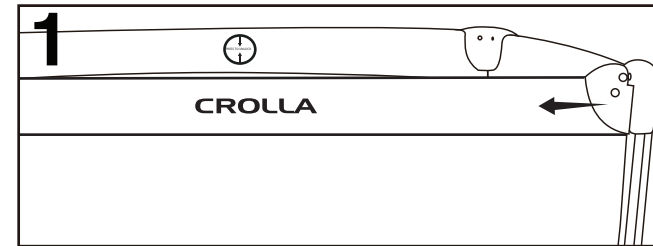

SWITCH TO SLEEPING MODE

- Fasten the connecting belt buckles around the frame or mattress of the adult bed.
- To prevent entrapment and ensure safety, the bedside sleeper must be securely fastened to the adult bed using the attachment system.
- Never use pillows, blankets, or any other items that pose suffocation hazards to fill the gap.

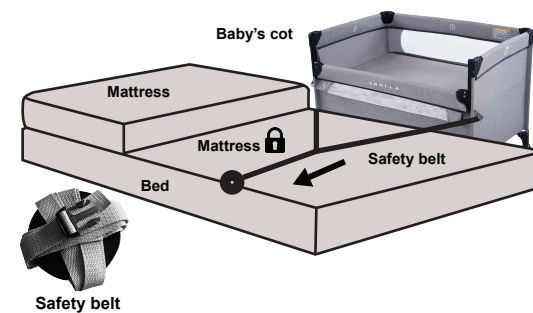

Safety belt



To adjust the slide door down, press the button below on both side and pull down the slide door

Care and Maintenance

1. Your travel cot can be spot cleaned with a sponge and soapy water.
2. Do not use undiluted neutral detergent, gasoline or other organic solvent to wash the travel cot. It may cause damage to the travel cot.
3. To wash carry bag, machine wash in lukewarm water and drip-dry. Do not use bleach.
4. At the beach or in the garden, clean sand and grit off your travel cot. Sand in the long rail locks may cause damage.
5. From time to time, check your travel cot for worn parts, torn material or stitching. Replace or repair the parts as needed.
6. If the travel cot is not in use for a long period of time, please put it in the shade where your child cannot access it.

Keep Your Child Safe
For Every Journey

TOP SAFETY | EXTRA COMFORT | ELEGANT DESIGN

CROLLA
ALLY

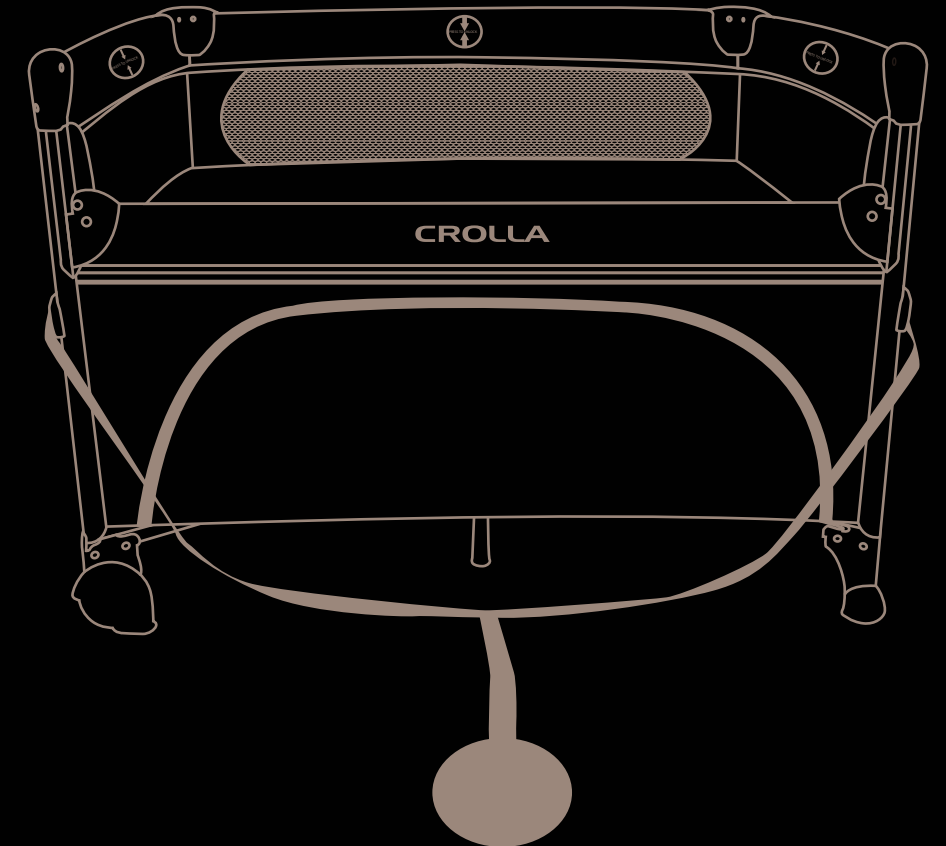

INTRODUCTION

IMPORTANT. KEEP FOR FUTURE REFERENCE. READ CAREFULLY

Please take a few minutes to read this user guide. The travel cot, including side rails and bottom pad, should be fully erected prior to use. Top rails must be completely locked.

The travel cot is intended for use by a child who is unable to climb out of the travel cot and is less than 86,4 cm (34") tall and weighs less than 15 kgs.

⚠ WARNING

- Adult assembly required.
- Please save instruction manual for future reference.
- Read all the instructions in this manual before using product.
- Discontinue using travel cot when child reaches 15kg (approximately 86cm in height) or is able to climb out.
- Discontinue using bassinet when child can sit, kneel or roll over or pull itself up.
- The lowest position of the mattress is the safest and the base shall always be used in that position as soon as the baby is old enough to sit up.
- Failure to follow these warnings and instructions could result in danger.
- Do not use the cot if any part is broken, torn or missing and use only spare parts approved by the manufacturer.
- NEVER leave your child unattended. Always keep your child in view.
- Use the travel cot with only one child at a time.
- Do not use more than one mattress in the travel cot.
- DO NOT leave anything in the travel cot or place the travel cot close to another product, which could provide a foothold or present a danger of suffocation or strangulation, e.g. strings, blind curtain cords etc.
- Always use travel cot on a flat, level floor.
- Be aware of the risk of open fire and other sources of strong heat such as electric bar fires, gas fires, etc in the near vicinity of the travel cot.
- To avoid strangulation, DO NOT place items with a string around your child's neck, suspend strings from this product, or attach strings to toys.
- All assembly fittings should always be tightened properly and that fittings should be checked regularly and retightened as necessary.
- Make sure the product has been folded or unfolded completely before letting your child approach the travel cot.
- You must attend to your child while it is in the bassinet.
- Do not place the bassinet in a dangerous place.
- Always keep accessories out of child's reach. Remove the accessories when child is able to pull itself up in the travel cot.
- Only use the mattress sold with this cot, do not add a second mattress on this one, suffocation hazards.

ASSEMBLY

Please read all the instructions in this manual before setting up and using this product.

1. Undo the two hook and loop fasteners.
2. Remove base mattress.
3. Pull the short rails up until both become rigid. If not rigid, pull up again until they are rigid.
If short rails do not latch, raise the center of floor halfway up, and then pull up again to latch the rails.
4. Latch the long rails.
5. Push the center of floor down. (Be sure all rails have locked before lowering center.)
6. Place the mattress
7. While installing mattress, soft side up
8. The travel cot is now ready to use.

FOLD TRAVEL COT

9. Remove the mattress.
10. Pull the folding webbing upward. Do not unlock rails yet. Center of floor must be halfway up before rails will unlock.
11. Unlock all four rails by following these steps.
 - Slightly lift the center of the rails, squeeze the latch button on the rail to release the two tubes.
 - Do not force fold. ! Both tubes must be released for the rail to fold, if rail does not fold completely, please lift the center of floor higher, and then try again from step
12. Fold the unit, but do not force. If unit will not fold, look for a partially latched rail. Squeeze the latch button to release the rail.
13. Wrap the travel cot with the mattress. Guide the hook and loop fasteners through the rings and attach them.
14. Place the travel cot into the bag and zip it.
15. The travel cot is now ready for easy carry and storage.

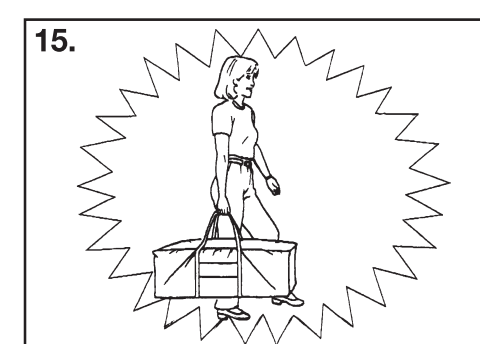
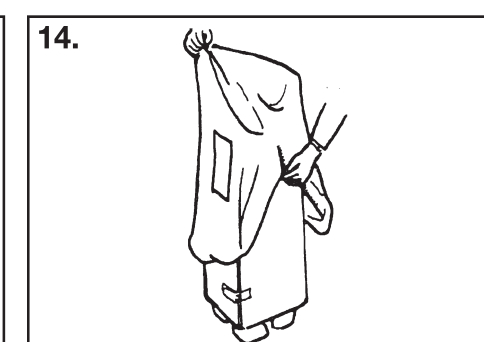
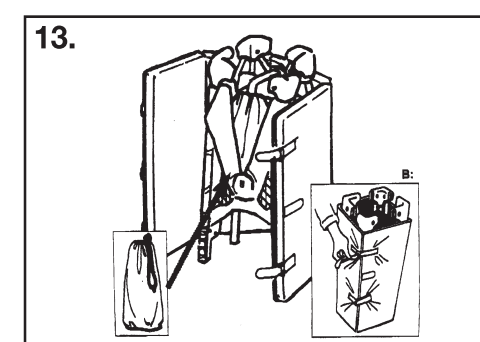
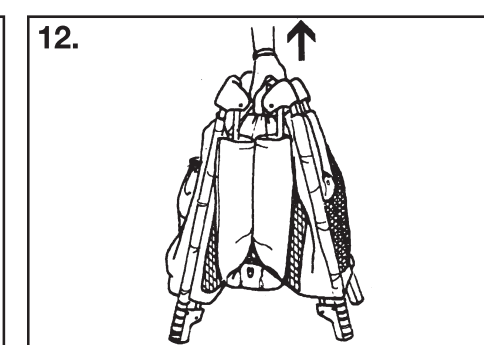
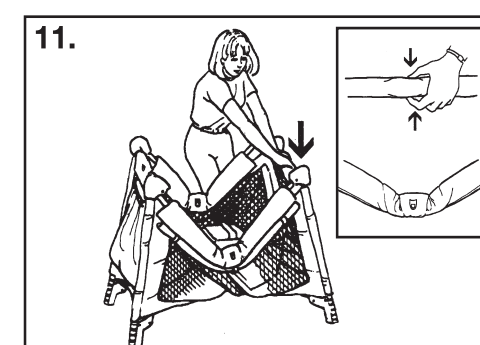
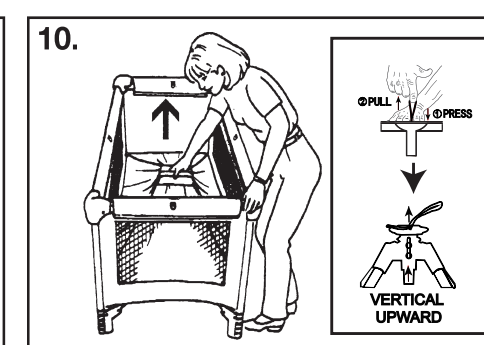
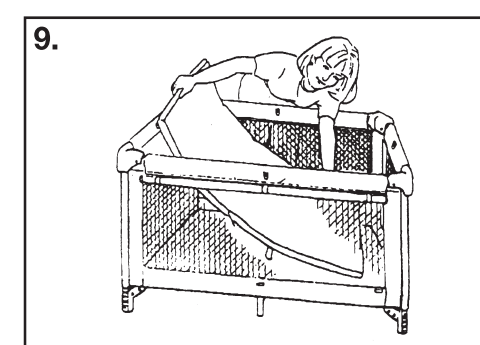
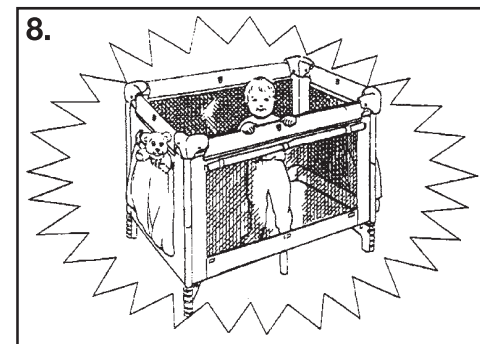
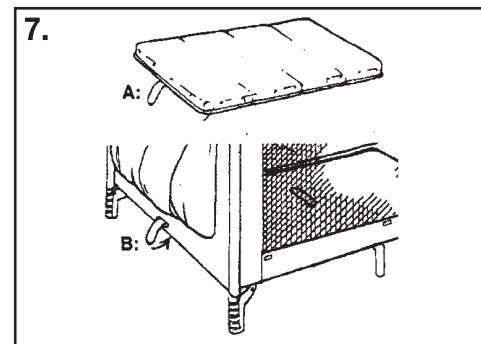
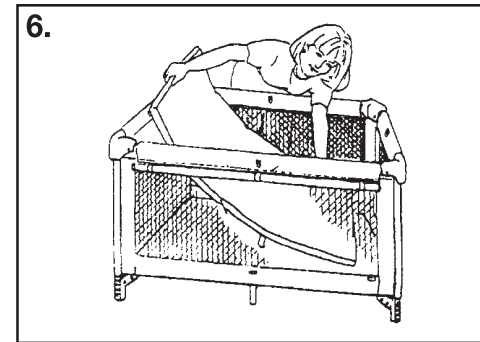
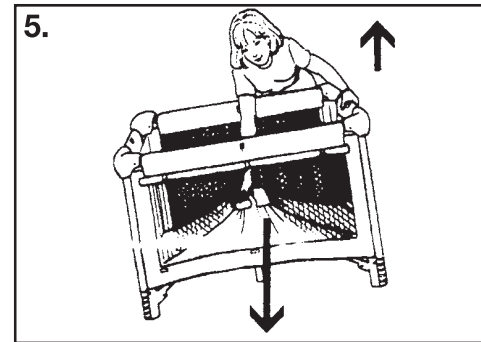
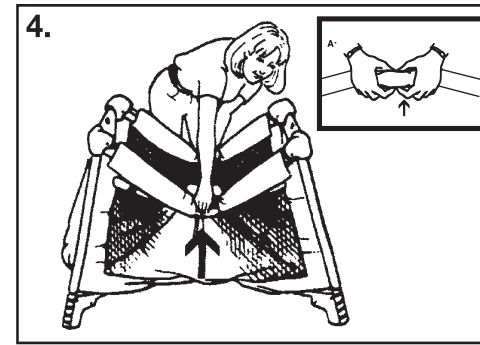
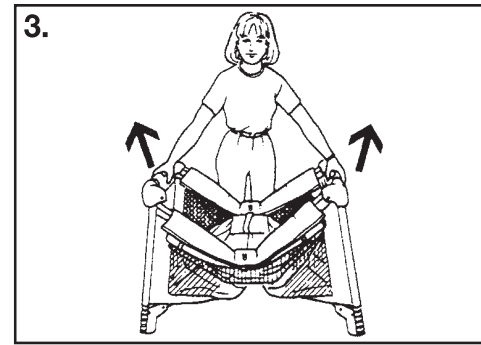
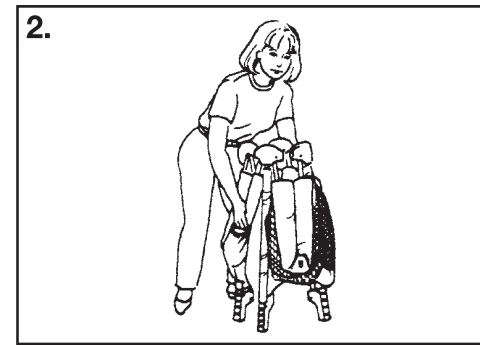
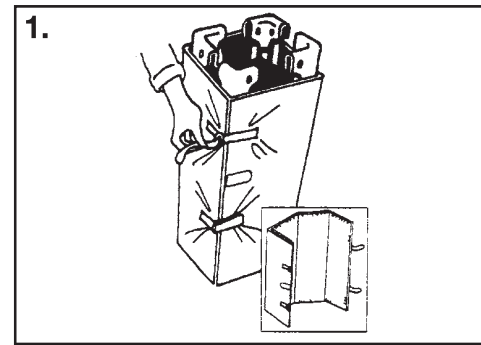

Instructions • 0 - 36 months



CROLLA



Warranty registration, visit to www.crollababy.com